

USER MANUAL

FAULT LOOP IMPEDANCE METER

MZC-306

MZC-306



Charger socket

USB interface



Indication of charging status

Charger and a USB socket with the sliding flap

Measuring terminals

Start the measurement procedure

Touch Electrode

Approving selected function

ESC - return to previous function, exit the function

Shift/selection right / left, up / down

Power on/off

Selection of additional meter's settings

Turning the display backlight on/off

ROTARY SWITCH FOR SELECTING FUNCTIONS
Selecting the measurement function:

- Z_{PE} **RCD** - measurement of short circuit loop impedance in L-PE circuit protected with a residual current device (RCD)
- Z_{N-L} , U_{N-L} , U_{N-L-L} - measurement of fault loop impedance in the circuit L-N or L-L
- Z_{PE} U_{L-PE} - measurement of fault loop impedance in the circuit L-PE
- **MEM** - View and erase the memory content and data transmission

Buttons to review the results

Straps loops



USER MANUAL

FAULT LOOP IMPEDANCE METER MZC-306



**SONEL S.A.
Wokulskiego 11
58-100 Świdnica**

Version 1.10 24.08.2022

The MZC-306 meter is a modern, easy and safe in use measuring device. Please acquaint yourself with the present manual in order to avoid measuring errors and prevent possible problems related to operation of the meter.

CONTENTS

1 Safety	4
2 Measurements	5
2.1 Selection of general measurement parameters	5
2.2 Remembering the last measurement result	7
2.3 Measurement of alternating voltage	7
2.4 Checking the correctness of PE (protective earth) connections	7
2.5 Measurement of fault loop parameters	8
2.5.1 Selection of measurement parameters	8
2.5.2 Prospective short-circuit current	10
2.5.3 Measurement of fault loop parameters in the L-N and L-L circuits	11
2.5.4 Measurement of fault loop parameters in the L-PE circuit	13
2.5.5 Measurement of short circuit loop impedance in L-PE circuit protected with a residual current device (RCD)	15
3 Memory of measurement results	17
3.1 Storing the measurement results data in the memory	17
3.2 Viewing memory data	19
3.3 Deleting memory data	20
3.3.1 Deleting bank data	20
3.3.2 Deleting the whole memory	21
3.4 Communication with PC	23
3.4.1 Set of accessories to connect the meter to a PC	23
3.4.2 Data transmission	23
3.4.3 Software update	23
4 Troubleshooting	24
5 Power supply of the meter	25
5.1 Monitoring of the power supply voltage	25
5.2 Replacing batteries (rechargeable batteries)	25
5.3 Charging rechargeable batteries	26
5.4 General rules of using the Nickel Metal Hydride (Ni-MH) batteries	27
6 Cleaning and maintenance	27
7 Storage	28
8 Dismantling and disposal	28
9 Technical specifications	29
9.1 Basic data	29
9.2 Additional data	32
9.2.1 Additional uncertainties according to IEC 61557-3 (Z)	32
10 Accessories	32
10.1 Standard accessories	32
10.2 Optional accessories	33
11 Manufacturer	34
12 Laboratory services	35

1 Safety

MZC-306 meter is designed for performing check tests of protection against electric shock in mains systems. The meter is used for making measurements and providing results to determine safety of electrical installations. Therefore, in order to provide conditions for correct operation and accuracy of obtained results, the following recommendations must be observed:

- Before you proceed to operate the meter, acquaint yourself thoroughly with this manual and observe the safety regulations and specifications provided by the producer.
- Any application that differs from those specified in the manual may result in a damage to the device and constitute a source of danger for the user.
- MZC-306 meters must be operated only by appropriately qualified personnel with relevant certificates authorising the personnel to perform works on electric systems. Operating the meter by unauthorised personnel may result in damage to the device and constitute a source of danger for the user.
- Using this manual does not exclude the need to comply with occupational health and safety regulations and with other relevant fire regulations required during the performance of a particular type of work. Before starting the work with the device in special environments, e.g. potentially fire-risk/explosive environment, it is necessary to consult it with the person responsible for health and safety.
- It is unacceptable to operate:
 - ⇒ a damaged meter which is completely or partially out of order,
 - ⇒ a meter with damaged insulation,
 - ⇒ a meter stored for an excessive period of time in disadvantageous conditions (e.g. excessive humidity). If the meter has been transferred from a cool to a warm environment with a high level of relative humidity, do not start measurements until the meter is warmed up to the ambient temperature (approximately 30 minutes).
- One should remember that when the word **batt** appears on the display, it indicates insufficient voltage of power supply and the need to charge the accumulator or replace batteries. Measurements performed by means of the meter whose supply voltage is too low are burdened with additional errors that are impossible to be estimated by the user. Such measurements must not be relied on in order to state correctness of protection of a network tested.
- Battery spill and damage to the meter may occur if discharged batteries are left in the meter.
- Before measurements may commence, make sure the leads are connected to the appropriate measurement sockets.
- Do not operate a meter with an open or incorrectly closed battery (accumulator) compartment or power it from other sources than those specified in the present manual.
- Repairs may be performed only by an authorised service point.

ATTENTION!

Only standard and additional accessories for a given device should be used, as listed in the "Equipment" section. Using other accessories may cause damage to measuring terminals and introduce additional measurement uncertainty.

Note:

An attempt to install drivers in 64-bit Windows 8 may result in displaying "Installation failed" message.

Cause: Windows 8 by default blocks drivers without a digital signature.

Solution: Disable the driver signature enforcement in Windows.

Note:

Due to continuous development of the meter's software, the actual appearance of the display, in case of some of the functions, may slightly differ from the display presented in this operating manual.

2 Measurements

WARNING:

During measurements, the earthed parts and parts accessible in the electrical installation being tested must not be touched.

WARNING:

During a measurement, switching of the range switch is forbidden because it may damage the meter and pose a threat to the user.

2.1 Selection of general measurement parameters

①

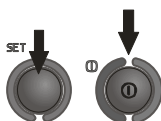

Keeping **SET** button pressed, turn on the meter and wait for the parameter selection screen.

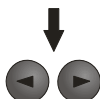

Use ◀ and ▶ buttons to go to the next parameter.



Use ▲ and ▼ buttons to change the parameter value. The value or symbol to be changed is flashing.

Symbol **YES** indicates an active parameter, while symbol **no** - indicates an inactive parameter.

2

Set the parameters according to the following algorithm:

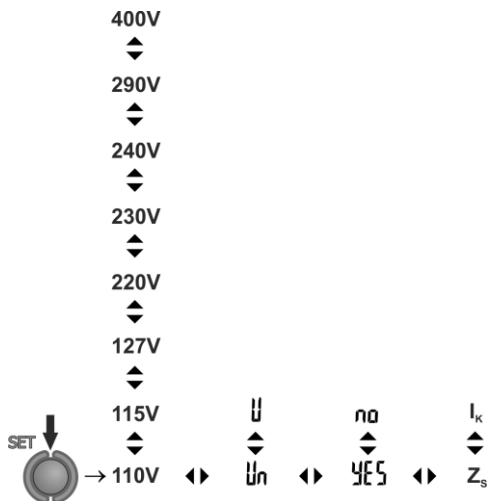

Parameter	System voltage	Voltage for calculating I_k : rated / measured	Auto-OFF	Main result of fault loop impedance measurement
Symbol(s)	L-N! U_n	I_k	OFF	dISP

3



Press **ENTER** to validate the changes and go to the measurement function,

or

4



Press **ESC** to go the measurement function without validating the changes.

Note:

Before the first measurements, select the mains rated voltage U_n (110/190V, 115/200V, 127/220V, 220/380V, 230/400V, 240/415V, 290/500V or 400/690V) used in the area where measurements are made. This voltage value is used for calculating the values of prospective short-circuit current, if this option was chosen from the main menu (**dISP**).

- After turning the meter on and displaying the software version, a current nominal system voltage is displayed: phase voltage in the main field and interphase voltage in the auxiliary one.

2.2 Remembering the last measurement result

The result of the latest measurement is remembered by the meter until a next measurement is started or measurement settings are changed or the measuring function is changed by means of the rotary switch. When you go to the voltage measurement screen with the **ESC** button, you can recall this result by pressing **ENTER**. Use the same button to recall the last result after powering the meter off and on (if the position of function selector has not been changed)

2.3 Measurement of alternating voltage

The meter measures and displays alternating mains voltage before the measurement. This voltage is measured for the frequencies within the range of 45..65 Hz. The test leads should be connected as for a given measuring function.

2.4 Checking the correctness of PE (protective earth) connections

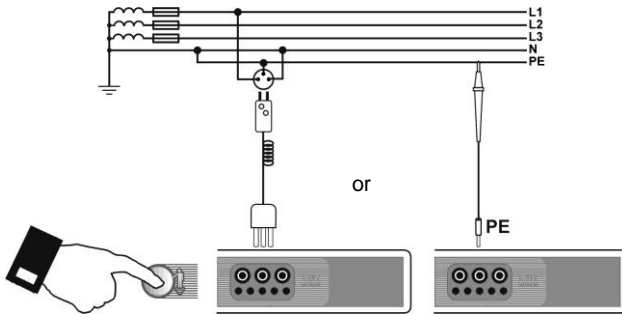

After connecting the meter according to the drawing, touch the contact electrode with a finger and wait for about 1 second. When voltage is found on **PE** the meter displays symbol **PE** (error in the installation; PE connected to the phase conductor) and generates a continuous beep. This option is available for the Z_{L-PE} measurements.

Note:

WARNING:
When a dangerous voltage is detected on PE conductor, measurements must be immediately stopped and a fault in the installation must be removed.

- The person making a measurement must ensure that he/she is standing on a non-insulated floor during the measurement; otherwise the result may be incorrect.
- The threshold value, which triggers the signal of exceeded allowable voltage on PE conduit, is approximately 50 V.
- In the Z_{L-PE} and Z_{L-PE} **RCD** functions, when only the phase conductor is connected to one of the measuring terminals of the meter (L,N,PE), the "PE" alarm will be generated when the contact electrode is touched. When in the Z_{L-PE} and Z_{L-PE} **RCD** functions only L and N conductors are connected (respectively to the meter's L and N terminals), the "PE" alarm may be triggered when the contact electrode is touched, but sometimes this does not happen (this depends, among other things, on the floor resistance, mains voltage, footwear, etc.).

2.5 Measurement of fault loop parameters



If there are residual current devices in the network tested, they should be bypassed by bridging for the period of impedance measurement. However, it should be remembered that the tested circuit is modified in this way and the obtained results may slightly differ from the actual results.

After completing measurements, always remove modifications introduced to the tested system for the period of measurements and check the operation of the residual current switch.

The above remark does not apply to measurements of short circuit loop impedance with Z_{L-PE} **RCD** function.



Measurements of fault loop impedance performed downstream of inverters are ineffective and their results are unreliable. This is due to the instability of internal impedance in inverter circuits during its operation. The measurements of fault loop impedance should not be performed directly downstream of inverters.

2.5.1 Selection of measurement parameters

1

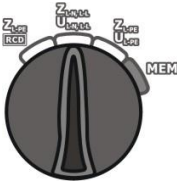

Turn the rotary switch to one of the loop impedance measurement ranges.

2

Set the phase conductor length according to the following algorithm, and according to the rules described in general parameters setting.

NOTE: The Uni-Schuko WS-xx lead is detected by the meter and it is then impossible to select the cable length (the --E symbol is displayed). Before starting the measurement with test leads terminated with banana plugs, select the appropriate length of the phase conductor, compatible with the length of the test lead used for measurement.

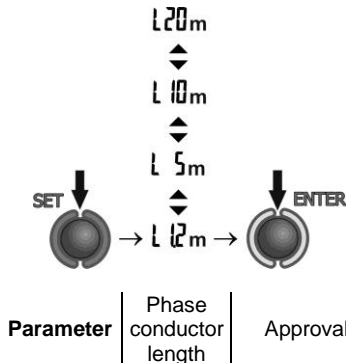

Note:



Cables from known manufacturers and selection of the correct length guarantees the declared measurement accuracy.



The leads with Uni-Schuko plugs can be used only in mains below 250V.

2.5.2 Prospective short-circuit current

The meter always measures impedance. The short-circuit current is calculated according to the following formula:

$$I_k = \frac{U}{Z_s}$$

where:

Z_s - measured impedance,

U - voltage that depends on settings of I_k (sec. 2.1 step ②):

$I_k(U_n)$	$U = U_n$
$I_k(U_0)$	$U = U_0$

where:

U_n – nominal voltage of the network,

U_0 – voltage measured by the meter.

On the basis of U_n rated voltage selected (section 2.1), the meter automatically recognizes the measurement at phase-to-neutral or phase-to-phase voltage and takes it into account in the calculations.

If the voltage of the network being tested is outside the tolerance range, the meter will not be able to determine a proper rated voltage for the short-circuit current calculation. In such a case, horizontal dashes will be displayed instead a short-circuit current value. The following diagram shows voltage ranges for which short-circuit current value is calculated.

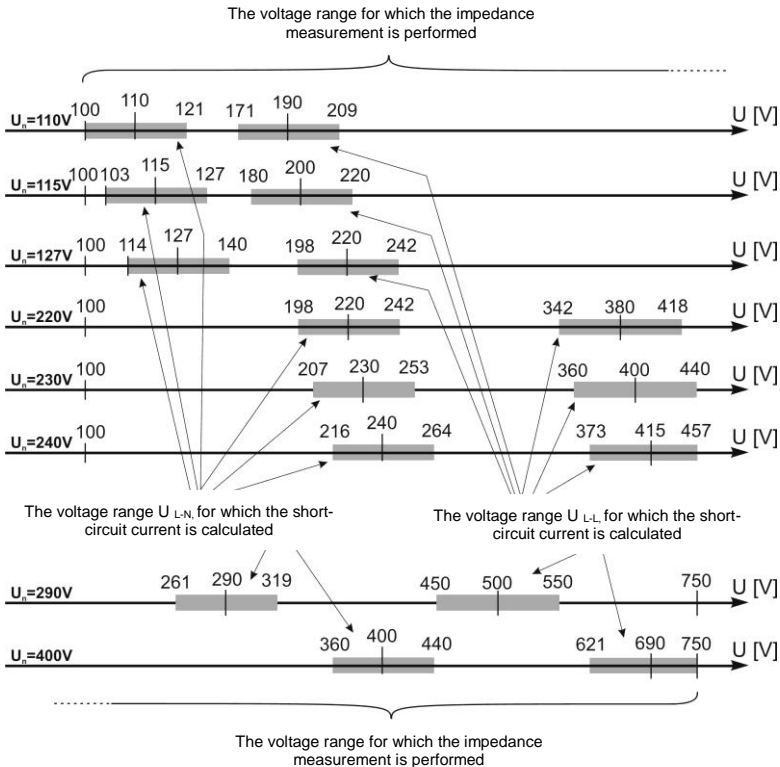

2.5.3 Measurement of fault loop parameters in the L-N and L-L circuits

1

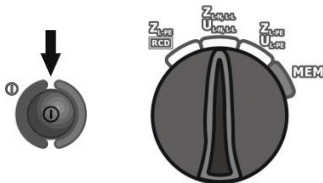

Turn on the meter.
Turn the rotary switch to the $Z/U_{L-N,L-L}$ position.

2

Depending on the needs, select the measurement parameters according to section 2.5.1.

3

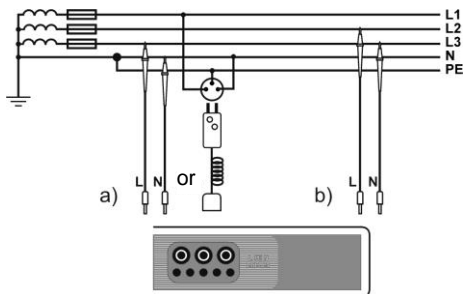

Connect test leads according to the drawing a) for measurement in the L-N circuit or b) for measurement in the L-L circuit

4

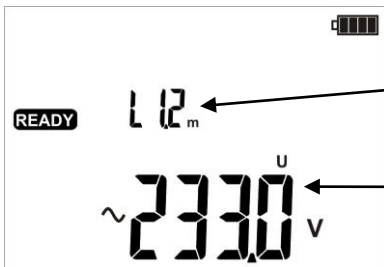

The meter is ready for measurement.

Phase conductor length or the $\text{---}E$ symbol.

U_{L-N} voltage

5

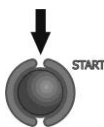

Make measurement by pressing **START** push-button.

6

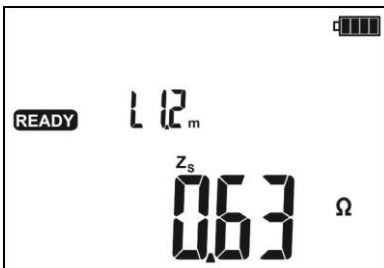

Read the main measurement result: fault loop impedance Z_S or short-circuit current I_K .

7

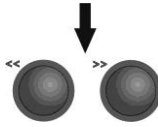

To read additional results, press the << and >>.

8

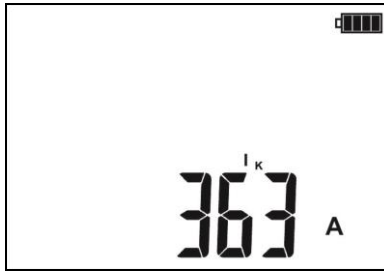

I_K
short-circuit
current or
 Z_S
fault loop
impedance

9

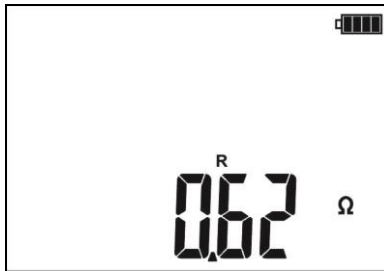

R
fault loop
resistance

10

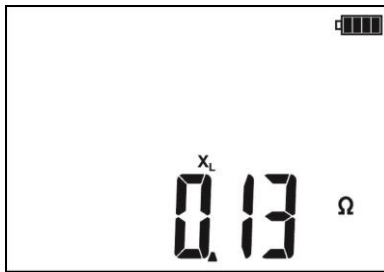
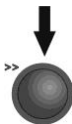

X_L
fault loop
reactance



Mains volt-
age at the
time of
measurement

Note:

- Enter the result into memory (see section 3.2) or press **ESC** to return to the voltage measurement.
- When many measurements are made in short time intervals, the meter may emit a large amount of heat. As a result of this, the housing of the device may become hot. This is normal and the meter is equipped with the protection against excessive temperature.
- Minimum interval between successive measurements is 5 seconds. This is controlled by the meter which displays the message **READY** informing that the measurement can be made.

Additional information displayed by the meter

READY	The meter is ready for measurement.
L-N!	Voltage on terminals L and N is not within the measurable range.
Err	Error during the measurement.
ErrU	Error during the measurement – voltage loss after the measurement
E00	Short circuit malfunction!
	L and N reversed. Signalling works if you use WS-xx lead or PE lead additionally.

2.5.4 Measurement of fault loop parameters in the L-PE circuit

1

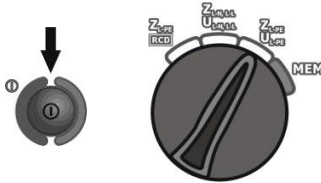

Turn on the meter.
Turn the rotary switch to the **Z/U_{L-PE}** position.

2

Depending on the needs, select the measurement parameters according to section 2.5.1.

3

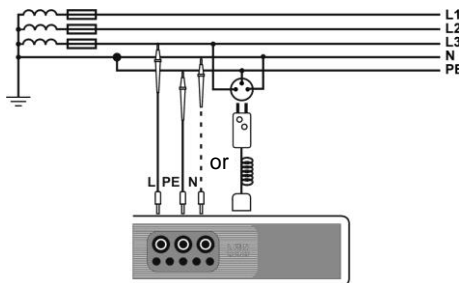

Connect test leads according to one of the drawings.

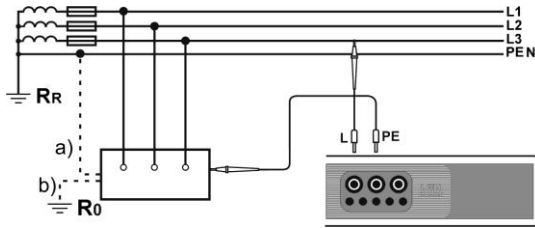

Checking effectiveness of protection against electric shock of the enclosure in case of: a) TN b) TT.

4

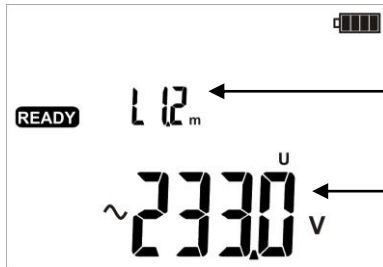

The meter is ready for measurement.

Phase conductor length or the $\sim E$ symbol.

U_{L-PE} voltage

5



Make measurement by pressing **START** push-button.

Remaining issues connected with the measurements are the same as those described for measurements in L-N circuit or L-L circuit.

Note:

- If you do not use the lead with AC power plug, a double cable measurement is possible.

Additional information displayed by the meter

READY	The meter is ready for measurement.
L-N!	For the lead with the plug - voltage on terminals L and N is not within the measurable range.
L-PE!	Voltage on terminals L and PE is not within the measurable range.

All remaining messages as in case of measurement in L-N and L-L circuit.

Additional information displayed by the meter

READY	The meter is ready for measurement.
L-N!	Voltage on terminals L and N is not within the measurable range.
L-PE!	Voltage on terminals L and PE is not within the measurable range.
	Conductor N is not connected.
NOISE!	This message displayed after the measurement indicates major noise in the system during the measurement. The measurement result may be affected by a large, unspecified error.

All remaining messages as in case of measurement in L-N and L-L circuit.

3 Memory of measurement results

MZC-306 meters are equipped with the memory that can store 3500 single measurement results. The whole memory is divided into 10 memory banks with 99 cells in each bank. Thanks to dynamic memory allocation, each of the memory cells can contain different quantity of single measurement results, depending on the needs. Optimal use of the memory can be ensured in this way. Each measurement result can be stored in a memory cell marked with a selected number and in a selected memory bank. Thanks to this, the user of the meter can, at his/her option, assign memory cell numbers to individual measurement points and the memory bank numbers to individual facilities. The user may also perform measurements in any chosen sequence and repeat them without losing other data.

Memory of measurement results **is not deleted** when the meter is switched off. Thanks to this, the data can be later read or sent to a computer. The number of a current memory cell or memory bank is not changed either.

Note:

- Results of measurements performed for all measuring functions can be stored in one memory cell.

- After each entry of the measurement result to the cell, its number is automatically incremented. Set the appropriate cell number to allow entering to a single cell of successive measurement results relating to a given measuring point (facility).

- Only the results of measurements triggered by **START** push-button may be stored in the memory.

- It is recommended to delete the memory after reading the data or before performing a new series of measurements that may be stored into the same memory cells as the previous ones.

3.1 Storing the measurement results data in the memory

①



Press **ENTER** after finishing the measurement.
The meter is in the memory storing mode.

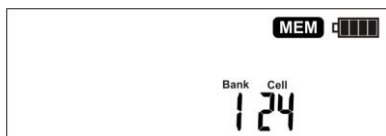

You can change a cell number by pressing ▲ and ▼ a bank number by pressing ◀ and ▶ .



The cell is empty.



The cell contains the result of the same type which is to be entered.

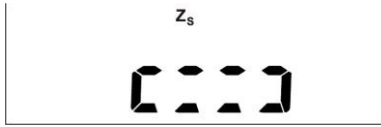

The cell contains the result of a different type than is to be entered.

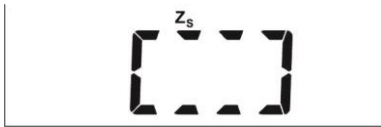

The cell is completely full.

②

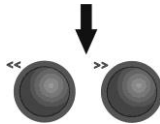

You can view different types of results and their components using buttons << , >>.



③



Select the bank and cell number or leave the current number. Then press **ENTER** again. The screen (shown below) appears for a moment, accompanied by three short beeps, and then the meter returns to display the last result of the measurement.

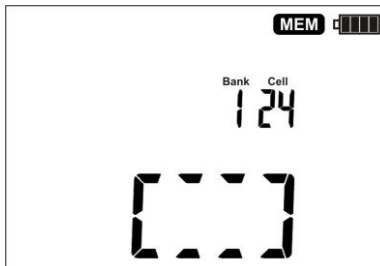

4

An attempt to overwrite a result causes the warning symbol to appear.



5

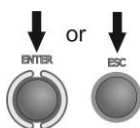

Press **ENTER** to overwrite the result or **ESC** to abort.

Note:

- Complete set of results (main result and supplementary results) for a given measuring function and preset measurement settings are stored in the memory.

3.2 Viewing memory data

1

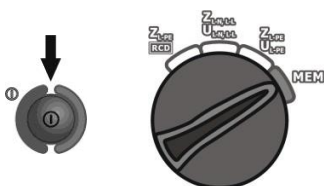

Turn on the meter.
Turn the rotary switch to the **MEM** position.

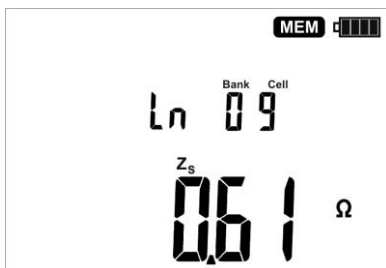

The content of the last saved cell appears.

Changing the number of cells and the bank and viewing the results is performed as in section 3.1.

Additional information displayed by the meter

L_n	Measurement made in L-N loop for Z_{L-N} , Z_{L-L} function
LL	Measurement made in the L-L loop for Z_{L-N} , Z_{L-L} function
LPE	Measurement made for Z_{L-PE} function
LPE alternating with rcd	Measurement made for Z_{L-PE} RCD function

3.3 Deleting memory data

3.3.1 Deleting bank data

①

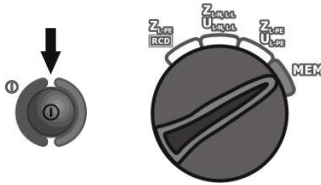

Turn on the meter.
Turn the rotary switch to the **MEM** position.

②

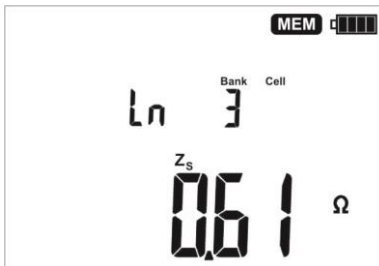

Set the bank number to be deleted.
Set the cell number before "1"...



...the cell number disappears, and the **del** symbol indicating the readiness to delete appears.

3



Press **ENTER** push-button.

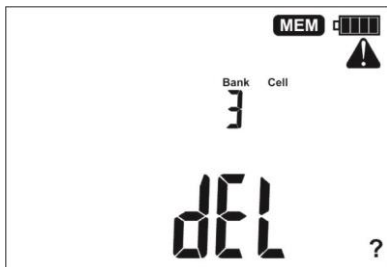

"?" and symbols appear, asking you to confirm deletion.

4



Press **ENTER** to start deleting or **ESC** to abort.

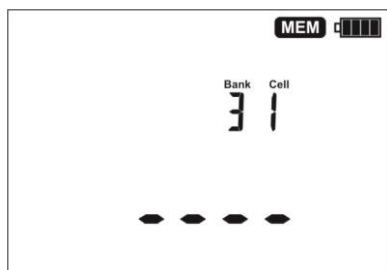

The deletion progress is shown on the display in %. When deletion is complete, the meter generates three short beeps and sets the cell number to 1.

3.3.2 Deleting the whole memory

1

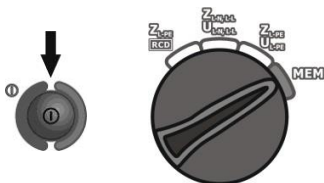

Turn on the meter. Turn the rotary switch to the **MEM** position.

2

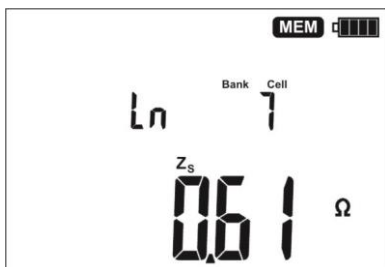

Set the bank number between "0" and "9"...

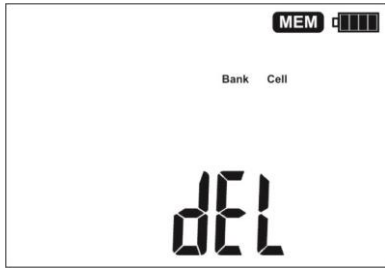

...the bank number disappears, and symbol **DEL** is displayed, indicating the readiness to delete.

3



Press **ENTER** push-button.

“?” and  symbols appear, asking you to confirm deletion.



4



Press **ENTER** to start deleting or **ESC** to abort.

The deletion progress is shown on the display in %. When deletion is complete, the meter generates three short beeps and sets the cell number to 1.

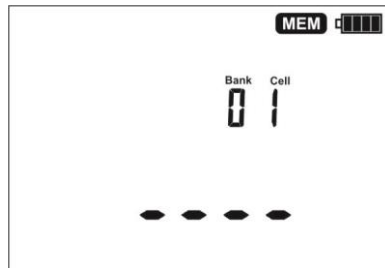

3.4 Communication with PC

Remarks:

- Data transmission is not possible during the charging of accumulators.

3.4.1 Set of accessories to connect the meter to a PC

In order to operate the meter with a PC, a cable for serial transmission and appropriate software are required. If this package has not been purchased along with the meter, it can be bought from the manufacturer or an authorized distributor where detailed software information is also available.

3.4.2 Data transmission

If the switch is in the **MEM** position, after detecting the USB connection with the computer the meter automatically goes to the data transmission mode and displays the following screen.



To transmit data, follow the instructions of the software.

3.4.3 Software update

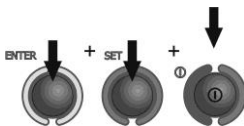

Turn on the meter by pressing and keeping **ENTER** and **SET** buttons.

The meter displays the following screen.





After connecting the meter to a PC using a USB cable, follow the instructions of the software.

4 Troubleshooting

Before returning the meter for repair, call the service, perhaps the meter is not damaged, and the problem has occurred for another reason.

The meter repairs should be carried out only in the outlets authorized by the manufacturer.

The following table describes recommended activities in some situations that may occur during operation of the meter.

Symptom	Cause	Proceeding
<p>The meter does not start after pressing button </p> <p>During the voltage measurement the following symbol is displayed: </p> <p>The meter turns off during the initial test.</p>	Discharged or incorrectly placed batteries/ rechargeable batteries.	Check if the batteries are placed correctly, replace and/or recharge the rechargeable batteries. If this does not help, sent the meter for servicing.
Measurement errors after moving the meter from cold environment to a warm and humid place.	No acclimatization.	Do not perform the measurements until the meter reaches the ambient temperature (about 30 minutes) and dries.
Consecutive results obtained in the same measuring point are significantly different from each other.	Incorrect connections in the tested system.	Check the connections and remove defects.
	The network with high noise or unstable voltage.	Perform more measurements, average the results.
The meter indicates the values close to zero or zero irrespective of the location of measurement and these values are significantly different than expected.	Incorrectly selected test leads in the meter settings.	

5 Power supply of the meter

5.1 Monitoring of the power supply voltage

The charge level of the batteries or rechargeable batteries is indicated by the symbol in the right upper corner of the display on a current basis:

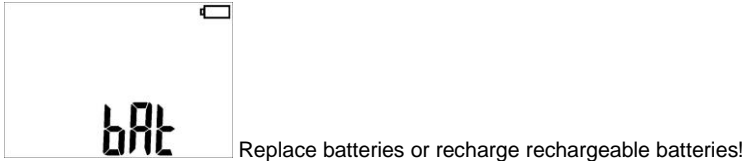
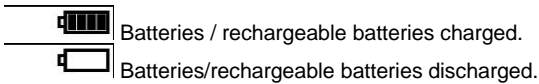

Note:

- Symbol **bat** in the display means that the supply voltage is too low and indicates that the batteries must be replaced or recharged.
- Measurements performed with an insufficient supply voltage will be at risk of additional errors which the user is unable to evaluate.

5.2 Replacing batteries (rechargeable batteries)

MZC-306 meter is powered from SONEL NiMH rechargeable battery pack. It is also possible to power the meter by using four LR14 batteries.

Battery charger is installed inside the meter and cooperates only with the manufacturer's accumulator pack. The charger is powered by external power supply adapter. It can be also powered from the car cigarette lighter socket. Both the accumulator pack and the adapter are standard components of the meter.

WARNING:
Before replacing the batteries or accumulators, disconnect the test leads from the meter.

In order to replace the package of accumulators it is necessary to do the following:

- Remove all the test leads from the sockets and turn the meter off,
- Remove the four screws of the accumulators/batteries compartment (in the lower part of the casing),
- Remove the compartment,
- Remove the compartment cover and remove the batteries (accumulators),
- Insert a new package of accumulators,
- Insert (snap) the compartment cover,
- Insert the compartment in the meter,
- Screw the four screws of the accumulators/batteries compartment.

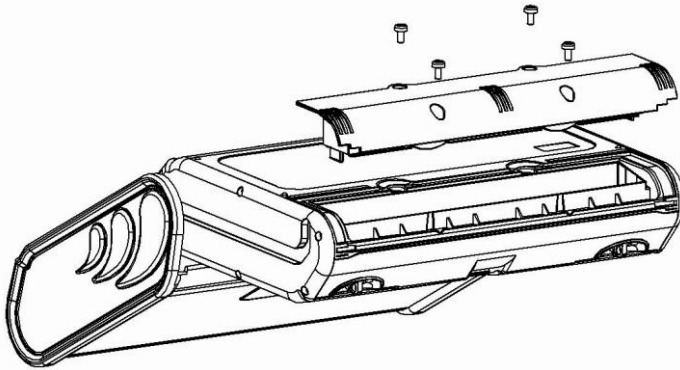

ATTENTION!

Do not use the meter when the accumulator compartment is removed or open or power it from other sources than those mentioned in this manual.

ATTENTION!

Have the meter serviced in case of battery leakage inside the compartment.

5.3 Charging rechargeable batteries

Charging commences after connecting the meter to the power supply, regardless of the fact if the meter is switched on or off. The rechargeable batteries are charged in accordance with the algorithm of "quick charge" – this process reduces the charging to approx. four hours. In order to turn the device off, unplug the power charger.

The charging process is indicated by displaying consecutive segments of the battery on LCD. In addition, the charging status is indicated by LED diode:

- slow blinking: charging in progress,
- fast blinking: emergency status,
- steady light: end of charging.

In case when you insert the batteries and connect the adaptor, the following message is displayed and charging is not started.



Note:

- As a result of interferences in the network it is possible that the process of charging of accumulators will finish too fast. When charging time is too short, turn off the meter and start charging again.

5.4 General rules of using the Nickel Metal Hydride (Ni-MH) batteries

- If you are not going to use the instrument for a longer time, remove the rechargeable batteries and store them separately.

- Store the rechargeable batteries in a dry, cool and well ventilated place and protect them from direct sunlight. The long storage temperature should be below 30 degrees C. If the batteries are stored long at high temperatures, the chemical processes may reduce their life.

- The NiMH rechargeable batteries usually withstand 500-1000 charging cycles. Such batteries achieve full capacity after forming (2-3 discharging and charging cycles). The most important factor which influences the battery life is the discharge level. The deeper the discharge level, the shorter the battery life.

- The memory effect appears in the NiMH batteries in a limited scope. These batteries can be recharged without more serious consequences. It is, however, recommended to discharge them completely every few cycles.

- During the storage of the Ni-MH rechargeable batteries, they are subject to self-discharge process at the rate of about 30% a month. Keeping the batteries at high temperatures may accelerate this process even two times. In order not to allow an excessive discharging of the batteries (after which the forming will be needed), recharge the batteries once in a while (even unused batteries).

- Modern, fast chargers detect too low and too high temperature of the batteries and respond accordingly. If the temperature is too low, the charging process should not start as it might irrevocably damage a rechargeable battery. The battery temperature increase is a signal to stop the charging and is typical. In addition to faster temperature increase of a battery which will not be fully charged, charging at high ambient temperatures results, however, in a reduced life.

- Remember that with fast charging, the batteries are charged to about 80% of their capacity; better results can be achieved by continuing the charging process: the charger then goes into the small current charging mode and after a few hours the batteries are fully charged.

- Do not charge and do not use the batteries at extreme temperatures as they reduce the life of batteries. Avoid using the battery-powered devices in very hot places. The rated operating temperature must be observed at all times.

6 Cleaning and maintenance

NOTE!

Use only the maintenance methods presented by the manufacturer in this manual.

Clean the meter casing and the case with a wet cloth, using generally available detergents. Do not use any solvents and cleaning media which could scratch the casing (powder, paste, etc.).

The meter electronic system is maintenance free.

7 Storage

When storing the instrument, observe the following recommendations:

- disconnect all leads from the meter,
- thoroughly clean the meter and all accessories,
- wind long test leads onto the spools,
- if you are not going to use the instrument for a longer time, remove the batteries,
- during a prolonged storage recharge the batteries from time to time to prevent total discharging.

8 Dismantling and disposal

Used electric and electronic equipment should be collected selectively, i.e. not placed with other types of waste.

Used electronic equipment shall be sent to the collection point according to the Used Electric and Electronic Equipment Act.

Before sending the instrument to the collection point, do not dismantle any parts by yourself.

Observe local regulations on disposal of packagings and used batteries.

9 Technical specifications

9.1 Basic data

⇒ Abbreviation "m.v." used in the specification of measurement uncertainty means a standard measured value

Voltage measurement

Range	Resolution	Basic uncertainty
0.0 ... 249.9 V	0.1 V	± (2% m.v. + 4 digits)
250...750V	1 V	± (2% m.v. + 2 digits)

- Frequency range: 45...65Hz

Measurement of short circuit loop impedance Z_{L-PE} , Z_{L-N} , Z_{L-L}

Measurement of short circuit loop impedance Z_s

Test range according to IEC 61557:

Test lead	Test range Z_s
1.2 m	0.13...1999 Ω
5 m	0.17...1999 Ω
10 m	0.21...1999 Ω
20 m	0.29...1999 Ω
WS-01, -05	0.19...1999 Ω

Display range:

Display range	Resolution	Basic uncertainty
0...19.99 Ω	0.01 Ω	± (5% m.v. + 3 digits)
20.0...199.9 Ω	0.1 Ω	± (4% m.v. + 3 digits)
200...1999 Ω	1 Ω	± (4% m.v. + 3 digits)

- Rated operating voltage U_{nL-N} / U_{nL-L} : 110/190V, 115/200V, 127/220V, 220/380V, 230/400V, 240/415V, 290/500V, 400/690V
- Operating voltage range: 100...440V (for Z_{L-PE} and Z_{L-N}) or 100...750V (for Z_{L-L})
- Rated mains frequency f_n : 50Hz, 60Hz
- Operating frequency range: 45...65Hz
- Maximum measuring current: 36.7A (10ms) for 690V, 21.3A (10ms) for 400V, 24.5A (10ms) for 230V, 12.2A (10ms) for 115V
- Checking the correctness of PE terminal connection by means of a contact electrode (applicable to Z_{L-PE})

Indications of short circuit loop resistance R_s and short circuit loop reactance X_s

Display range	Resolution	Basic uncertainty
0..19.99 Ω	0.01 Ω	± (5% + 5 digits) value Z_s
20.0..199.9 Ω	0.1 Ω	± (5% + 5 digits) value Z_s

- Calculated and displayed for $Z_s < 200 \Omega$

Indications of short-circuit current I_k

Test range according to IEC 61557 can be calculated on the basis of test ranges Z_S and rated voltages.

Display range	Resolution	Basic uncertainty
0.055...1.999 A	0.001 A	Calculated on the basis of uncertainty for fault loop
2.00...19.99 A	0.01 A	
20.0...199.9 A	0.1 A	
200...1999 A	1 A	
2.00...19.99 kA	0.01 kA	
20.0...69.0 kA	0.1 kA	

- Prospective fault current calculated and displayed by the meter may slightly differ from the value calculated by the user with a calculator, basing on the displayed value of the impedance, because the meter calculates the current from unrounded value of fault loop impedance (which is used for displaying). As the correct value, consider I_k current value, displayed by the meter or by firmware.

Measurement of short circuit loop impedance Z_{L-PE} **RCD** (without triggering of RCD)

Measurement of short circuit loop impedance Z_S

Test range according to IEC 61557:

Test lead	Test range Z_S
1.2 m	0.43...1999 Ω
5 m	0.47...1999 Ω
10 m	0.51...1999 Ω
20 m	0.59...1999 Ω
WS-01, -05	0.49...1999 Ω

Display range	Resolution	Basic uncertainty
0...19.99 Ω	0.01 Ω	\pm (6% m.v. + 10 digits)
20.0...199.9 Ω	0.1 Ω	\pm (6% m.v. + 5 digits)
200...1999 Ω	1 Ω	

- It will not trip RCD's of $I_{\Delta n} \geq 30\text{mA}$
- Rated operating voltage U_n : 110V, 115V, 127V, 220V, 230V, 240V, 390V, 400V
- Operating voltage range: 100 ... 440V
- Rated mains frequency f_n : 50Hz, 60Hz
- Operating frequency range: 45...65Hz
- Control of correctness of PE terminal connection by means of a touch electrode

Indications of short circuit loop resistance R_S and short circuit loop reactance X_S

Display range	Resolution	Basic uncertainty
0..19.99 Ω	0.01 Ω	\pm (6% + 10 digits) of Z_S
20.0..199.9 Ω	0.1 Ω	\pm (6% + 5 digits) of Z_S

- Calculated and displayed for $Z_S < 200 \Omega$

Indications of short-circuit current I_k

Test range according to IEC 61557 can be calculated on the basis of test ranges Z_s and rated voltages.

Display range	Resolution	Basic uncertainty
0.055...1.999 A	0.001 A	Calculated on the basis of uncertainty for fault loop
2.00...19.99 A	0.01 A	
20.0...199.9 A	0.1 A	
200...1999 A	1 A	
2.00...19.99 kA	0.01 kA	
20.0...40.0 kA	0.1 kA	

- Prospective fault current calculated and displayed by the meter may slightly differ from the value calculated by the user with a calculator, basing on the displayed value of the impedance, because the meter calculates the current from unrounded value of fault loop impedance (which is used for displaying). As the correct value, consider I_k current value, displayed by the meter or by firmware.

Other technical data

- type of insulation.....double, EN 61010-1 and IEC 61557 compliant
- measurement category IV 600V (III 1000V) acc. to EN 61010-1
- degree of protection of housing acc. to EN 60529..... IP54
- power supply of the meter.....
 - alkaline batteries 4x1.5 V LR14 (C) or accumulator package SONEL NiMH 4.8 V 4.2 Ah
- parameters of AC adapter for the battery charge 100 V...240 V, 50 Hz...60 Hz
- dimensions 288 x 223 x 75 mm
- meter weight (with batteries or rechargeable batteries).....about 2 kg
- storage temperature -20...+60°C
- operating temperature 0...+45°C
- temperature range suitable for initiating battery charging +10 °C to +40 °C
- temperatures at which loading is interrupted..... below +5 °C and above (or equal to) +50 °C
- humidity..... 20...80%
- reference temperature +23 ± 2°C
- reference humidity 40...60%
- altitude (above sea level) <2000 m
- Time to Auto-OFF 300 seconds
- number of Z measurements (for alkaline batteries) >5000 (2 measurements per minute)
- display modular LCD
- memory of measurement results..... 990 cells
- data transmission USB
- quality, design and manufacturing are ISO 9001 compliant
- the device meets the requirements of IEC 61557 standard
- the product meets EMC requirements (immunity for industrial environment) according to the following standards..... EN 61326-1 and EN 61326-2-2

9.2 Additional data

Data on additional uncertainties are useful mainly when the meter is used in non-standard conditions and for metrological laboratories for the purpose of calibration.

9.2.1 Additional uncertainties according to IEC 61557-3 (Z)

Significant parameter	Designation	Additional uncertainty
Position	E ₁	0%
Supply voltage	E ₂	0% (BAT is not lit)
Temperature 0...35°C	E ₃	1.2 m lead – 0Ω 5 m lead – 0.011Ω 10 m lead – 0.019Ω 20 m lead – 0.035Ω WS-01 lead, WS-05 – 0.015Ω
Phase angle 0..30° at the bottom of test range	E _{6.2}	0.6%
Frequency 99%..101%	E ₇	0%
Network voltage 85%..110%	E ₈	0%
Harmonic	E ₉	0%
DC component	E ₁₀	0%

10 Accessories

The current list of accessories can be found on the manufacturer's website.

10.1 Standard accessories

Standard set of equipment supplied by the manufacturer includes:

- MZC-306 meter
- WS-05 adapter with UNI-SCHUKO angular plug – **WAADAWS05**
- Test lead 1.2 m CAT III/1000V CAT IV/600V (banana plugs) red – **WAPRZ1X2REBB**
- Test lead 1.2 m CAT III/1000V CAT IV/600V (banana plugs) blue – **WAPRZ1X2BUBB**
- Test lead 1.2 m CAT III/1000V CAT IV/600V (banana plugs) yellow – **WAPRZ1X2YEBB**
- Pin probe 1 kV (banana socket) yellow – **WASONYEOGB1**
- Pin probe 1 kV (banana socket) red – **WASONREOGB1**
- Pin probe 1 kV (banana socket) blue – **WASONBUOGB1**
- Crocodile clip, red, 1 kV, 20 A – **WAKRORE20K02**
- Crocodile clip, blue, 1 kV, 20 A – **WAKROBU20K02**
- NiMH battery 4.8 V 4.2 Ah – **WAAKU07**
- Z7 Power supply adapter – **WAZASZ7**
- Mains power cable Euro 2-pin plug / IEC C7 plug – **WAPRZLAD230**
- USB cable – **WAPRZUSB**
- L4 carrying case – **WAFUTL4**
- Hanging straps – **WAPOZSZEKPL**
- User manual
- Factory calibration certificate

10.2 Optional accessories

Additionally, the following items that are not included in the scope of standard equipment can be purchased from the manufacturer or the distributors:

WAPRZ005REBB



- 5 m lead, red

WAPRZ020REBB



- 20 m lead, red

WAADAAGT16P - five-wire version WAADAAGT16C - four-wire version



- AGT-16P adapter for three-phase sockets

WAADAAGT63P - five-wire version



- AGT-63P adapter for three-phase sockets

WAPOJ1



- Battery container

WAPRZ010REBB



- 10 m lead, red

WAADAWS01



- WS-01 adapter for triggering the measurement with the UNI-Schuko plug

WAADAAGT32P - five-wire version WAADAAGT32C - four-wire version



- AGT-32P adapter for three-phase sockets

WAPRZLAD12SAM



- cable for charging the accumulator package from the car cigarette lighter socket
- calibration certificate with accreditation

11 Manufacturer

The manufacturer of the device and provider of warranty and post-warranty service:

SONEL S.A.

Wokulskiego 11
58-100 Świdnica
Poland

tel. +48 74 858 38 60

fax +48 74 858 38 09

E-mail: export@sonel.pl

Web page: www.sonel.pl

NOTE

Service repairs must be performed solely by the manufacturer.

12 Laboratory services

SONEL Testing and Calibration Laboratory has been accredited by the Polish Center for Accreditation (PCA) - certificate no. AP 173.

Laboratory offers calibration for the following instruments that are used for measuring electrical and non-electrical parameters.



AP 173

• METERS FOR MEASUREMENTS OF ELECTRICAL PARAMETERS

- voltage meters,
- current meters (including clamp meters),
- resistance meters,
- insulation resistance meters,
- earth resistance and resistivity meters,
- RCD meters,
- short-circuit loop impedance meters,
- power quality analyzers,
- portable appliance testers (PAT),
- power meters,
- multimeters,
- multifunction meters covering the functions of the above-mentioned instruments,

• ELECTRICAL STANDARDS

- calibrators,
- resistance standards,

• METERS FOR MEASUREMENTS OF NON-ELECTRICAL PARAMETERS

- pyrometers,
- thermal imagers,
- luxmeters.

The **Calibration Certificate** is a document that presents a relation between the calibration standard of known accuracy and meter indications with associated measurement uncertainties. The calibration standards are normally traceable to the national standard held by the National Metrological Institute.

According to ILAC-G24 „Guidelines for determination of calibration intervals of measuring instruments”, SONEL S.A. recommends periodical metrological inspection of the instruments it manufactures no less frequently than once every **12 months**.

For new instruments provided with the Calibration Certificate or Validation Certificate at the factory, recalibration should be performed within **12 months** from the date of purchase, however, no later than **24 months** from the date of purchase.

ATTENTION !

The person performing the measurements should be absolutely sure about the efficiency of the device being used. Measurements made with an inefficient meter can contribute to an incorrect assessment of the effectiveness of health protection and even human life.



NOTES

WARNINGS AND GENERAL INFORMATION DISPLAYED BY THE METER

ATTENTION!

MZC-306 meter is designed to operate at the rated phase voltage 110V, 115V, 127V, 220V, 230V, 240V, 290V, 400V and interphase voltage 190V, 200V, 220V,380V, 400V, 415V, 500V and 690V.

Connecting voltage higher than allowed between any of the test terminals may damage the meter and cause a hazard to the user.

L-N!	U_{L-N} voltage is incorrect for making a measurement.
L-PE!	U_{L-PE} voltage is incorrect for making a measurement.
N-PE!	U_{N-PE} voltage voltage exceeds allowable value.
	Phase connected to terminal N instead of L.
READY	The meter is ready for measurement.
NOISE!	This message displayed after the measurement indicates major noise in the system during the measurement. The measurement result may be affected by a large, unspecified error.
Err	Error in the measurement.
ErrL	Error in the measurement: loss of voltage after the measurement.
EOO	Short circuit malfunction!
ULn	Conductor N is not connected.
⌂	Measurement blocked by the thermal protection. Long beep after pressing the START button.
 bAtt	Status of batteries or accumulators: Batteries or accumulators charged. Batteries/accumulators discharged. Batteries/accumulators fully discharged.
Accu	Attempting to charge the battery.



SONEL S.A.
Wokulskiego 11
58-100 Świdnica
Poland



+48 74 858 38 60
+48 74 858 38 00
fax +48 74 858 38 09

e-mail: export@sonel.pl
www.sonel.pl